

SMALL STEAM TRAIN



*Plans by
Darryl Yeager
EASY TO LOVE
P.O. BOX 205
BELLWOOD, PA 16617
PH 814-742-7407
Web Site www.ez2love.com*

SMALL STEAM TRAIN
Page 2
ENGINE PARTS
Parts Full Scale

Part No.	Description	Quantity	Size
1.	Base Steam	1	15.88 cm x 4.45 cm x 1.91 cm
4.	Wheels	4	3.18 cm x 1.27 cm Wheels
5.	Axel & Hitch Pegs for all Bases 5 per Base except Engine	5	.64 cm Axel Pegs
11.	Boiler Steam or Passenger	1	5.08 cm x 3.18 cm Dowell Rod
12.	Smoke Stack Steam or Passenger	1	.64 cm x 3.33 cm Smokestack
17.	Engine Cab	1	6.03 cm x 3.81 cm x 3.18 cm
18.	Cab Roof	1	5.72 cm x 4.76 cm x .95 cm

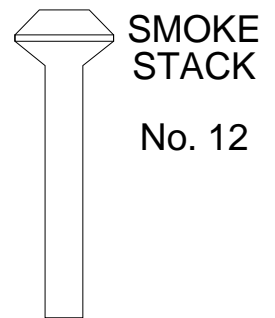
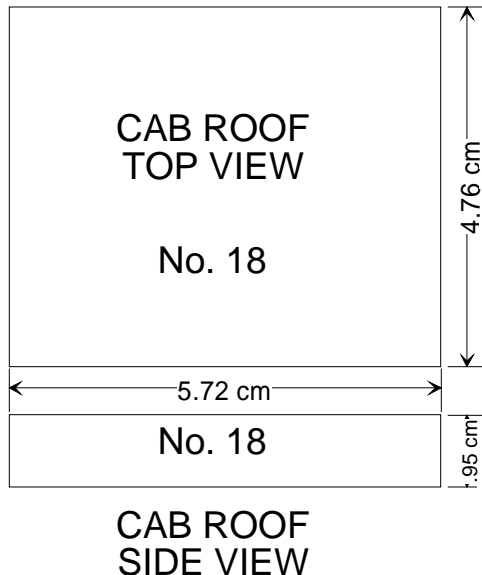
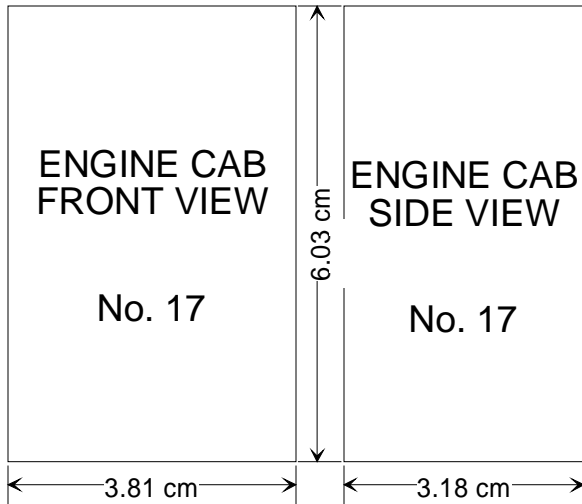
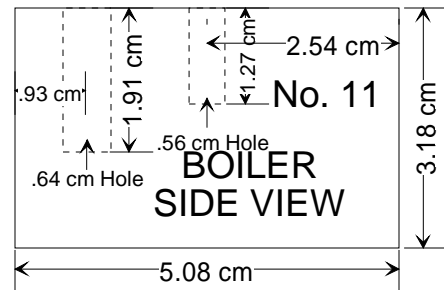
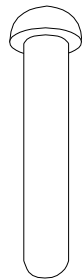
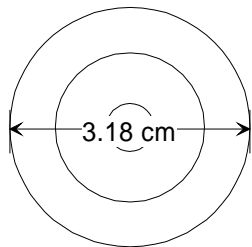
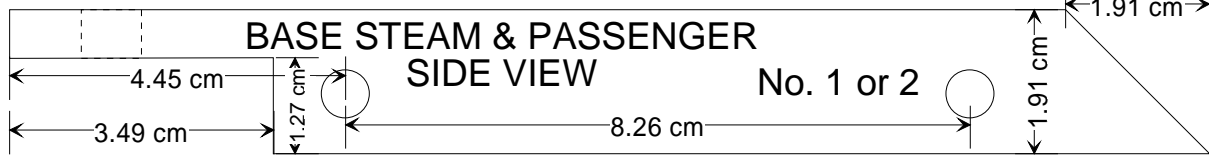
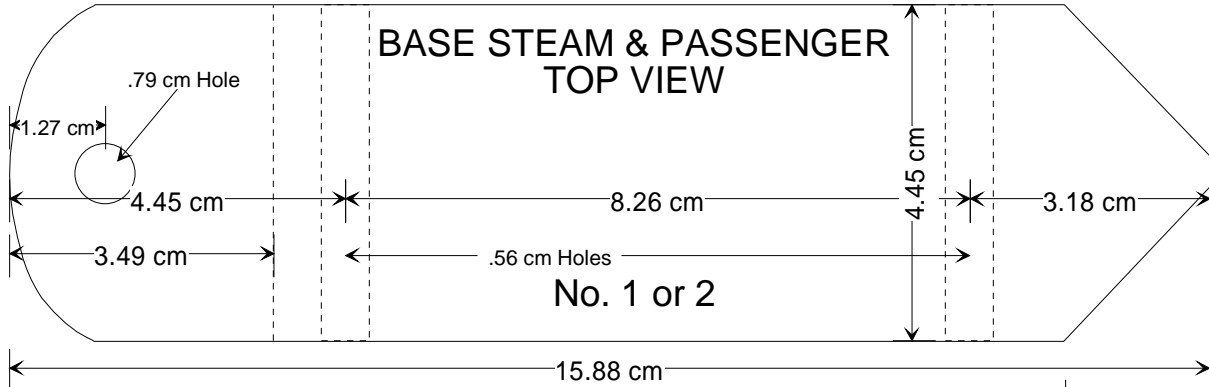

SMALL STEAM TRAIN
Page 3
CAR BASES
Parts Full Scale

Part No.	Description	Quantity	Size
6.	Base Freight Car	1	15.88 cm x 4.45 cm x 1.91 cm
8.	Base Tender	1	13.97 cm x 4.45 cm x 1.91 cm
10.	Base Caboose	1	15.88 cm x 4.45 cm x 1.91 cm

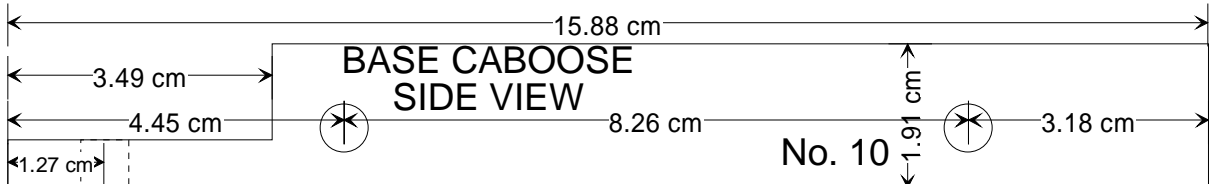
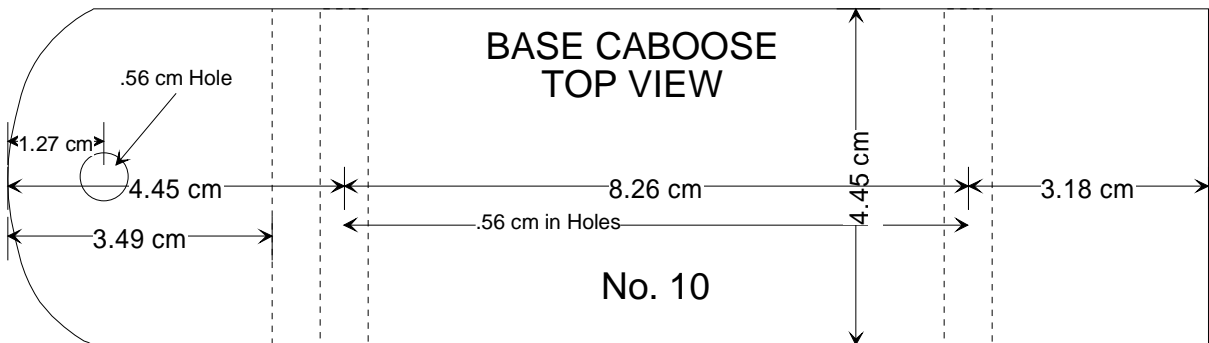
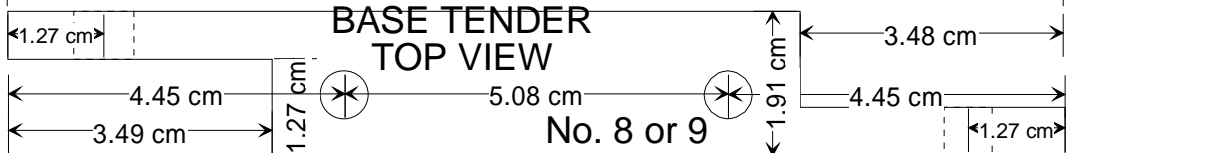
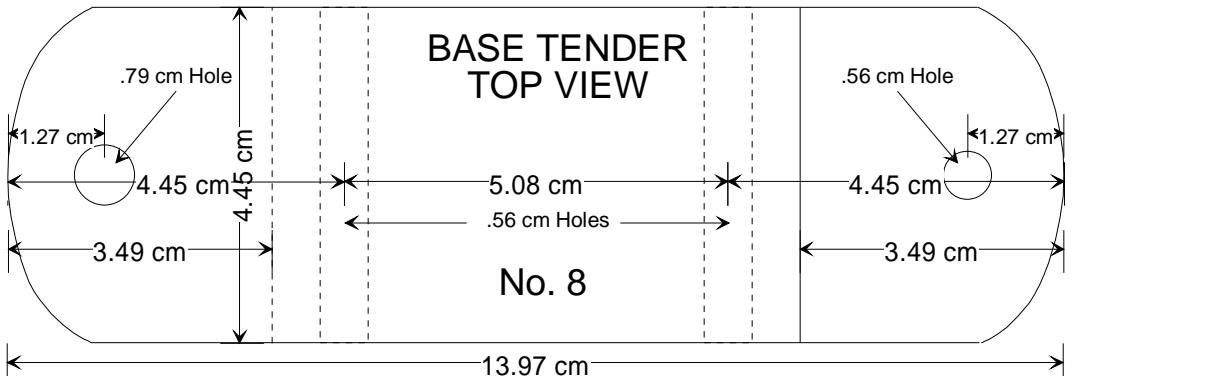
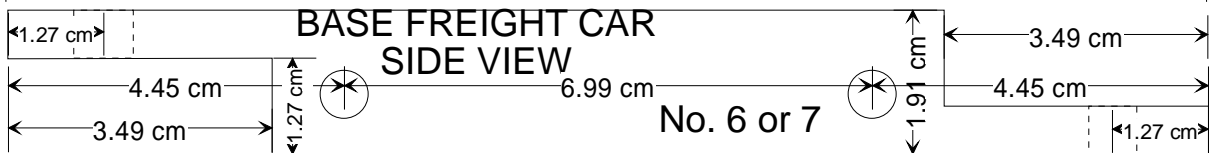
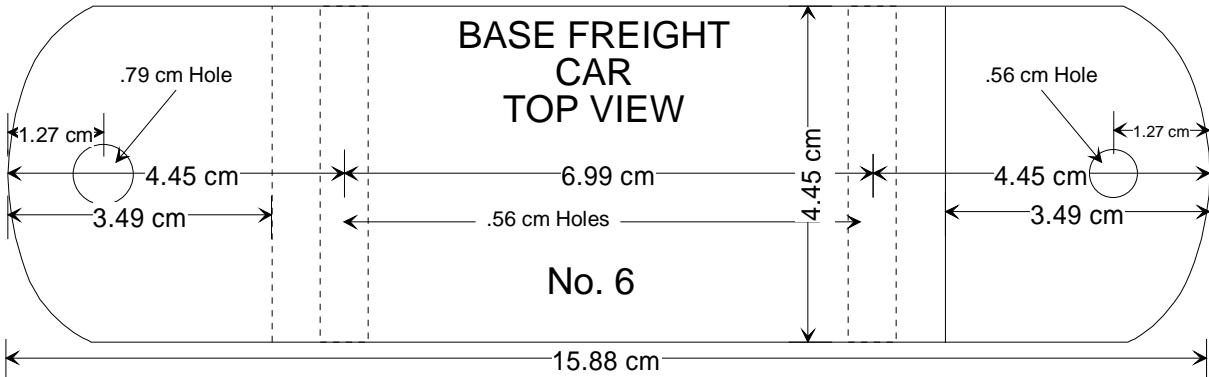

SMALL STEAM TRAIN
Page 4
BOX CAR, TENDER &
CABOOSE PARTS
Parts Full Scale

Part No.	Description	Quantity	Size
19.	Box Car Body	1	8.89 cm x 3.81 cm x 3.18 cm
21.	Box Car Roof	1	10.16 cm x 4.76 cm x .95 cm
23.	Tender Body	1	6.03 cm x 3.81 cm x 3.18 cm
26.	Caboose Body	1	8.89 cm x 3.18 cm x 3.18 cm
27.	Caboose Roof	1	4.76 cm x 4.76 cm x .95 cm
28.	Caboose Roof Spacer	1	2.54 cm x .95 cm Wheel

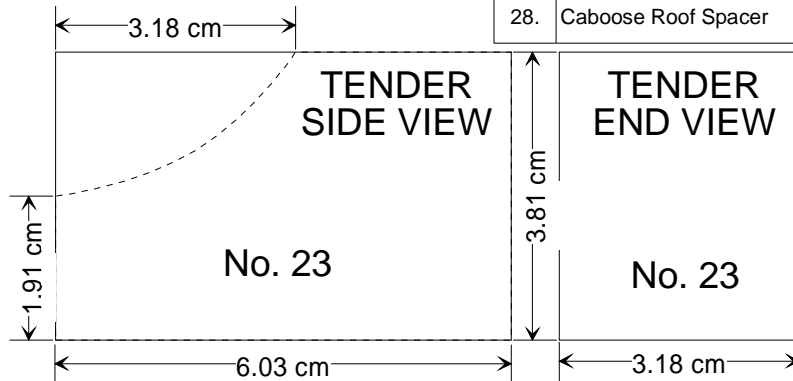

To create Darkened Holes in Passenger Cars use a Piece of 1.27 cm" Dowell Rod in Drill Press to Friction Burn the Holes. Drill .3175 cm" Pilot Hole to Guide the Dowell.

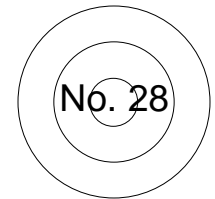
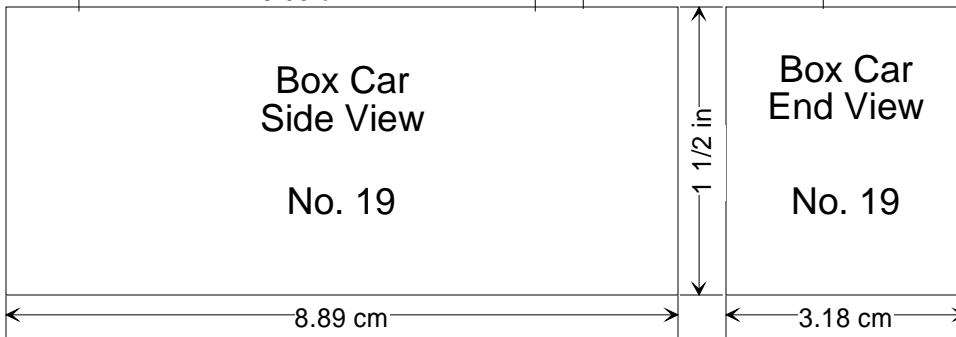

CABOOSE ROOF SPACER

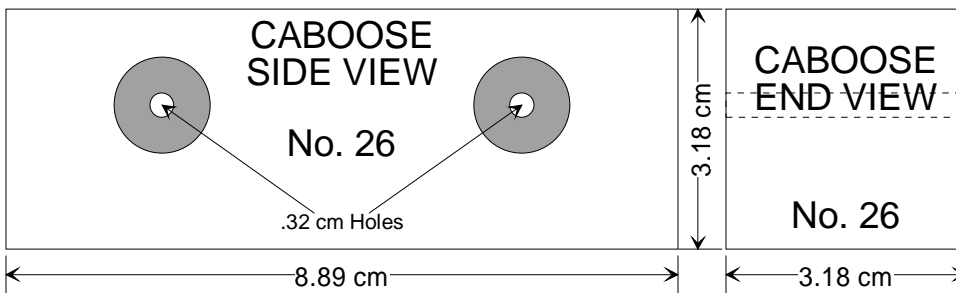
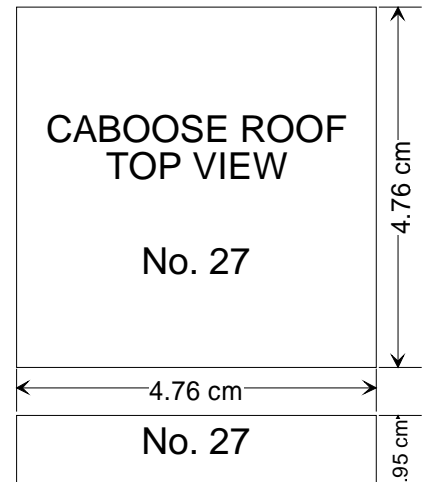
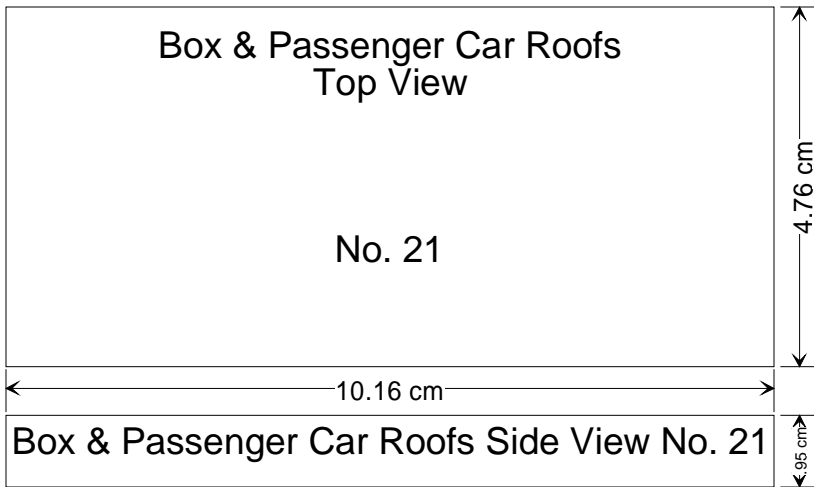

EXPLODED VIEWS

STEAM ENGINE

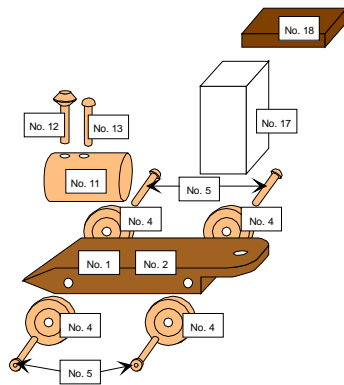

TENDER

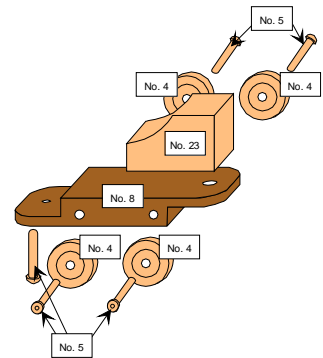

BOX CAR

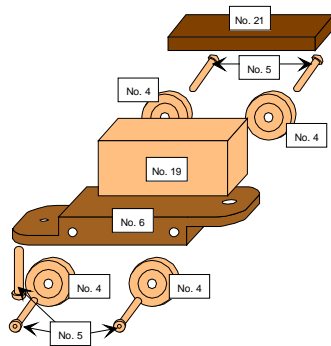

STEAM & DIESEL CABOOSE

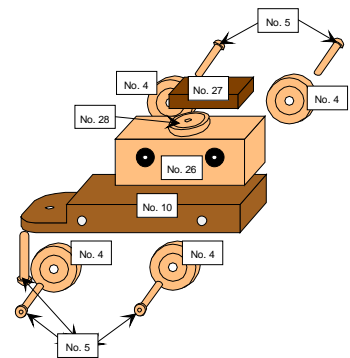

ASH



BIRCH



OAK



WALNUT

MATERIAL LIST

STEAM TRAIN

Quantity	Description	Size
1	Oak Base Parts	80 cm x 4.45 cm x 1.91 cm
1	Walnut Roof Parts	32 cm x 5.08 cm x .95 cm
1	Birch or Ash Body Parts	62 cm x 3.81 cm x 3.18 cm
20	Axels, Hitches, & Stacks	.64 cm Axel Pegs
1	Smokestacks	.64 cm x 3.33 cm Smokestack Pegs
1	Steam Boiler& Oil Tank Parts	31 cm x 3.18 cm Dowell Rod
1	Caboose Spacers	2.54 cm x .95 cm Wheels
16	Wheels	3.18 cm x 1.27 cm Wheels

** All Wooden Parts in the Material List are oversize. Get exact sizes from the Drawings.*

** Choice of types of Lumber is up to you. The types I listed were my choices.*

** Finish the toy with a Non-Toxic finish. I use vegetable oil. It works well and is safe.*